



tel: (11) 2038-8238 / 2359-8268

TIM: (11) 98301-5987 / CLARO: (11) 97604-1684

VIVO: (11) 99876-8098

www.AUTOMESSA.com.br

E-mail e MSN: vendas@automessa.com.br

Para verificar os valores de cada item, basta clicar nas IMAGENS

Todas as Peças para Accord até 1997 - Suspensão

<p>AX11010</p>  <p>Axial de Direção Accord 1994 à 1997 Cód. Orig. 53010-SV4-000 Medidas: 150 x 12 x 14mm</p>	<p>TD11008 ; TD11009</p>  <p>Terminal de Direção Accord até 1997</p>	<p>BDJ11016 ; BDJ11017</p>  <p>Bandeja Inferior Completa da Suspensão Dianteira Accord 1993 à 1996 Cód. Orig. 51355-SM4-040 ; 51365-SM4-040</p>	<p>BDJ11020 ; BDJ11021</p>  <p>Bandeja Inferior Completa da Suspensão Dianteira Accord 1996 à 1997 Cód. Orig. 51355-SV4-000 ; 51365-SV4-000</p>
<p>BDJ11018 ; BDJ11019</p>  <p>Bandeja Superior Completa da Suspensão Dianteira Accord 1993 à 1997 Cód. Orig. 51450-SV4-000 ; 51460-SV4-000</p>	<p>BCK11012</p>  <p>Kit de Buchas da Bandeja Superior da Suspensão Dianteira Accord até 1997 Medidas: altura 40mm x diametro 34mm x furo 10mm</p>	<p>PV11001</p>  <p>Pivô da Bandeja Inferior da Suspensão Dianteira Accord 1991 à 1993 - Accord 1994 à 1997 Cód. Orig. 51220-SM0-003</p>	<p>BCK11014</p>  <p>Kit de Buchas da Bandeja Inferior da Suspensão Dianteira Accord 91 à 93 - 1994 à 1997 Cód. Orig. 51810-SM4-004 ; 51393-SV1-A01</p>
<p>PVS11004</p>  <p>Pivô da Bandeja Superior da Suspensão Dianteira Accord 1993 à 1997 Cód. Orig. 51270-SR4-013</p>	<p>BCK11021 ; BCK11022</p>  <p>Kit de Buchas da Barra Estab. da Suspensão Dianteira Accord 1991 à 1994 Accord 1995 à 1997 Cód. Orig. 51306-SM4-961 ; 51306-SM4-010</p>	<p>BCH11026</p>  <p>Bucha da Suspensão Traseira (Facão) Accord 1992 à 1997</p>	
<p>COX11014</p>  <p>Kit de Buchas do Coxim Superior do Amortecedor Dianteiro Accord 1992 à 1993 - Accord 1994 à 1997- Accord 1998 à 2002</p>	<p>44036G/44037G</p>  <p>Imagem Ilustrativa Amortecedor Dianteiro (PAR) Accord 1991 à 1997</p>	<p>KTD11001</p>  <p>Par de Batente da Haste do Amortecedor Dianteiro Accord até 1997</p>	

tel: (11) 2038-8238 / 2359-8268

Celular VIVO: (11) 99876-8098

www.AUTOMESSA.com.br

E-mail e MSN: vendas@automessa.com.br



tel: (11) 2038-8238 / 2359-8268

TIM: (11) 98301-5987 / CLARO: (11) 97604-1684

VIVO: (11) 99876-8098

www.AUTOMESSA.com.br

E-mail e MSN: vendas@automessa.com.br

Para verificar os valores de cada item, basta clicar nas IMAGENS

<p>COX11014</p>  <p>Kit de Buchas do Coxim Superior do Amortecedor Traseiro Accord 1992 à 1993 - Accord 1994 à 1997- Accord 1998 à 2002</p>	<p>44025G</p>  <p>Amortecedor Traseiro (PAR) Accord 1991 à 1997</p>	<p>KTD11002</p>  <p>Par de Batente da Haste do Amortecedor Traseiro Accord até 1997</p>	
--	--	---	--

Todos os Coxins para Accord 1992 até 1993 de Motor e Câmbio

Honda Accord 1992 à 1993 (Manual)

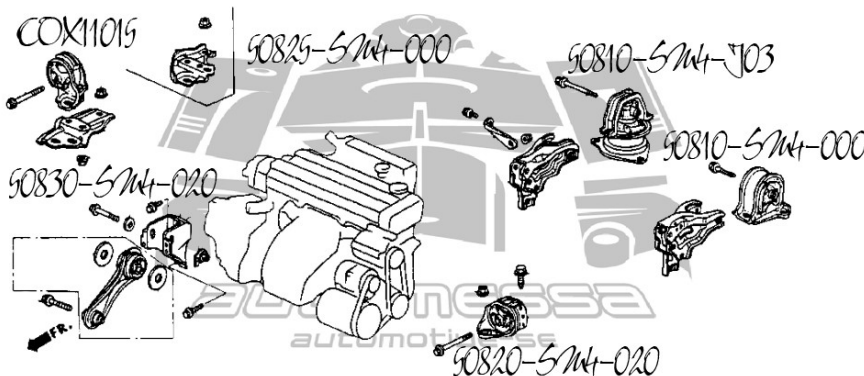

Accord 1992 à 1993 (Automático)

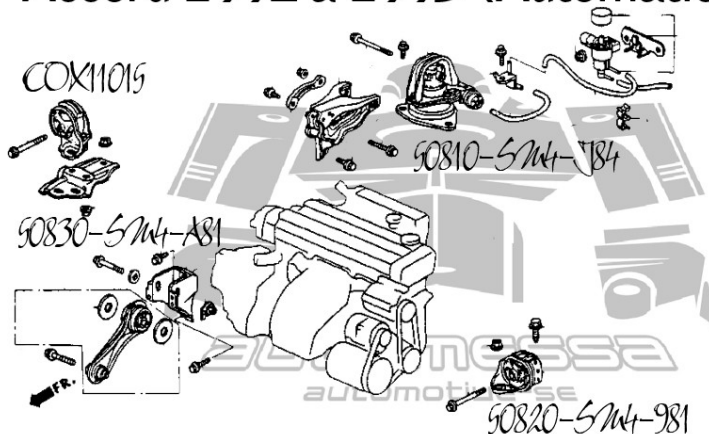

COX11015



Coxim Lado Direito Traseiro do Motor (Lado Câmbio)
Accord 1992 à 1993 (manual e aut.)
Cód. Orig. 50805-SM4-020

tel: (11) 2038-8238 / 2359-8268

Celular VIVO: (11) 99876-8098

www.AUTOMESSA.com.br

E-mail e MSN: vendas@automessa.com.br



tel: (11) 2038-8238 / 2359-8268

TIM: (11) 98301-5987 / CLARO: (11) 97604-1684

VIVO: (11) 99876-8098

www.AUTOMESSA.com.br



E-mail e MSN: vendas@automessa.com.br

Para verificar os valores de cada item, basta clicar nas IMAGENS

***Todos os Coxins para Accord 1994 até 1997 (Manual)
de Motor e Câmbio***

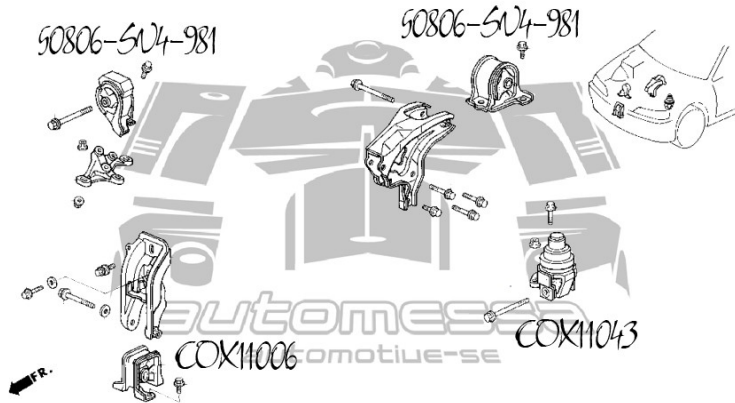
Honda Accord 1994 à 1997 (Manual)



<p>COX11006</p>  <p>Coxim Dianteiro (Central) do Motor Accord 1994 à 1997 (manual e aut.) Cód. Orig. 50804-SV4-980 ; 50804-SV4-000</p>	<p>COX11043</p>  <p>Coxim Dianteiro Lado Esquerdo do Motor Accord 1994 à 1997 (manual e aut.) Cód. Orig. 50820-SV4-J01</p>
--	---

***Todos os Coxins para Accord 1994 até 1997 (Automático)
de Motor e Câmbio***

Accord 1994 à 1997 (Automático)

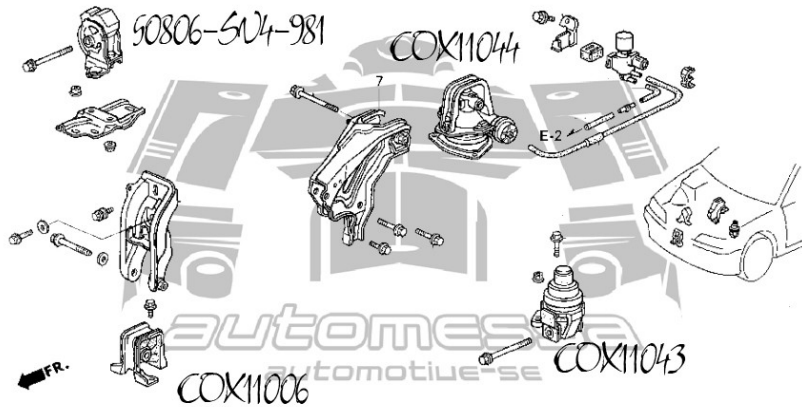

<p>COX11044</p>  <p>Coxim Traseiro do Câmbio Accord 1994 à 1997 (Automático) Cód. Orig. 50810-SV4-J82 ; 50810-SV4-J81</p>	<p>COX11006</p>  <p>Coxim Dianteiro (Central) do Motor Accord 1994 à 1997 (manual e aut.) Cód. Orig. 50804-SV4-980 ; 50804-SV4-000</p>	<p>COX11043</p>  <p>Coxim Dianteiro Lado Esquerdo do Motor Accord 1994 à 1997 (manual e aut.) Cód. Orig. 50820-SV4-J01</p>
--	---	---

tel: (11) 2038-8238 / 2359-8268

Celular VIVO: (11) 99876-8098

www.AUTOMESSA.com.br

E-mail e MSN: vendas@automessa.com.br



tel: (11) 2038-8238 / 2359-8268

TIM: (11) 98301-5987 / CLARO: (11) 97604-1684







VIVO: (11) 99876-8098

www.AUTOMESSA.com.br

E-mail e MSN: vendas@automessa.com.br

Para verificar os valores de cada item, basta clicar nas IMAGENS

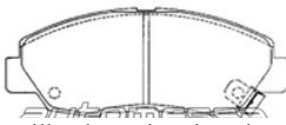
Todas as Peças para Accord até 1997 – Freio

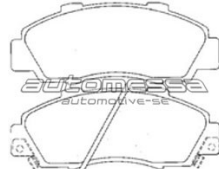
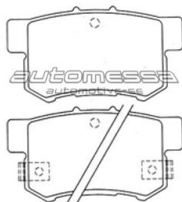
<p>CR11002</p>  <p>Cubo de Roda Dianteiro Accord 1991 à 1997 Cód. Orig. 44600-SM4-020</p>	<p>DFD11001</p>  <p>Disco de Freio Ventilado Dianteiro (PAR) Accord 1.8, 2.0 16V 1990 à 1993 Cód. Orig. 45251-SM4-000</p>	<p>DFT11002</p>  <p>Disco de Freio Sólido Traseiro (PAR) Accord 2.0/ 2.2 16V (94/...)/ Wagon (92/94) Cód. Orig. 42510-SM4-950</p>	<p>DFD11004</p>  <p>Disco de Freio Ventilado Dianteiro (PAR) Accord Wagon (91/...)/ V6 (95/...) Cód. Orig. 45251-SM5-A00</p>
<p>DFT11010</p>  <p>Disco de Freio Sólido Traseiro (PAR) Accord Coupé SEI 1989 Cód. Orig. 42510-SE0-000</p>	<p>PFD11001</p>  <p>Pastilha do Freio Dianteiro C/ Alarme Accord EX 2.0 CB 1989 à 1993 / 1.8i 16V (Aro 14") 1993 à 1997 Medidas: 137,5 x 52,5 x 18,3</p>	<p>PFD11008</p>  <p>Pastilha do Freio Dianteiro C/ Alarme Accord 2.0, 2.3, Aerodeck 2.0 (Aro 14") 1989/... Medidas: 137,5 x 53,5 x 18,35</p>	<p>PFD11011</p>  <p>Pastilha do Freio Dianteiro C/ Alarme (Disco Ventilado) Accord 1.8i 16V, 2.0i (c/ ABS), 2.2i 16V 1989 à 1997 / 2.3 1993 à 1995 Medidas: 148,7 x 57,7 x 18,0</p>
<p>PFT11012</p>  <p>Pastilha do Freio Traseiro C/ Alarme (Disco Sólido) Accord Todos 1993 à 1997 Medidas: 88,6 x 47,5 x 14,5</p>			

tel: (11) 2038-8238 / 2359-8268

Celular VIVO: (11) 99876-8098

www.AUTOMESSA.com.br

E-mail e MSN: vendas@automessa.com.br